







83 251 220

- Ausladung 55 mm

Passt zu ELIO, ENO, MEM, META SQUARE, SYNC und TARA ULTRA



Passt zu: ELIO, MEM, ENO, SYNC, TARA ULTRA, META SQUARE

	Platin	83 251 220-08
	Chrom	83 251 220-00
	Platin gebürstet	83 251 220-06
	Messing (23kt Gold)	83 251 220-09
	Dark Chrome	83 251 220-19
	Messing gebürstet (23kt Gold)	83 251 220-28
	Schwarz matt	83 251 220-33
	Champagne gebürstet (22kt Gold)	83 251 220-46
	Champagne (22kt Gold)	83 251 220-47
	Chrom gebürstet	83 251 220-93
	Dark Platinum gebürstet	83 251 220-99

83 251 220

mm [inches]

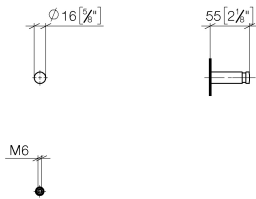

83 251 220

Ersatzteile für die
anderen
Oberflächenvarianten
finden Sie hier:
Chrom

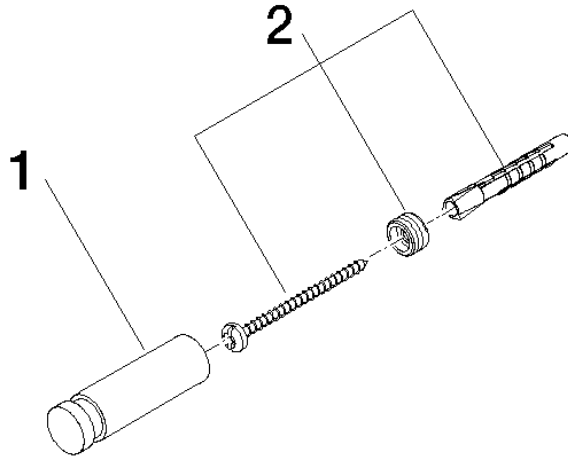

Ersatzteilstückliste

Nr.	Artikelnummer	Benennung	Verbaumenge	Lieferzeit
1	08 18 60 505-08	Haken	1	60
2	05 24 04 506 00 90	Befestigungssatz	1	2